

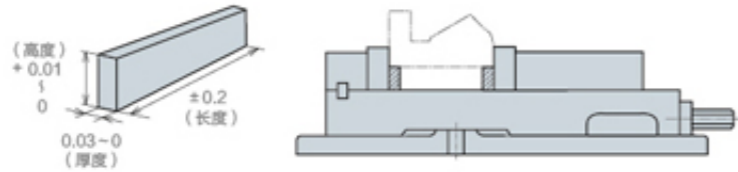

符合RoHS
PRECISION PARALLELS 4 PAIRS SETS
精密平行块套装

- 对端面以外的四个面均进行了磨削加工，并采取成对加工。
- 对S50C进行了HRC46-53的淬火处理，提高了耐磨损性。
- 放置在坚固的木质保管箱内。
- 可单件销售。

若使用高精度平行块确保平行度，可防止工件上浮，实现精密加工。



规格

订单号	型号	套装内容	重量kg
934597	HPA100SET	8×15×100 (HP27), 10×20×100(HP28) 10×25×100(HP29), 15×35×100(HP30)	各2个、每箱4组
934598	HPA125SET	8×15×125 (HP31), 10×20×125(HP32) 10×30×125(HP33), 15×40×125(HP34)	各2个、每箱4组
901278	HPA150SET	15×20×150(HP2), 15×30×150(HP3) 20×30×150(HP4), 25×50×150(HP5)	各2个、每箱4组
900097	HPA200SET	10×20×200(HP22), 15×20×200(HP23) 15×30×200(HP24), 20×30×200(HP25) 25×50×200(HP26)	各2个、每箱5组

●用于顶面加工...
尤其适用于薄板的顶面加工。

●用于通孔加工...
可防止刀具与平口钳发生冲突。

●用于小型工件的设置...
适用于中央带槽的平口钳的设置。

●用于防止擦伤平口钳
可防止因工件掉落而擦伤平口钳。

使用

未使用

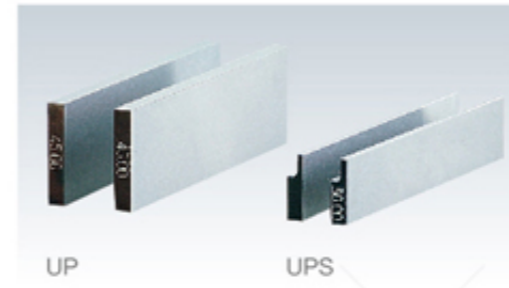
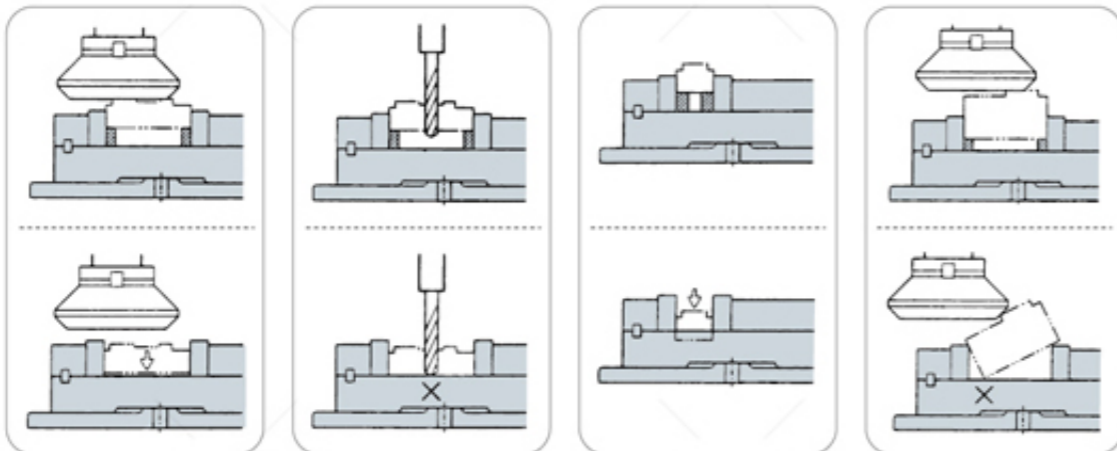

符合RoHS
PRECISION PARALLELS
薄型平行块

材质 S50C 热处理 淬火HRC47-53

- 设计高度时考虑了平口钳的钳口深度。
- 厚度薄，适用于工件端面附近的通孔加工。(带台阶型尤为适合)
- 2片1组(*对差:0.01)。

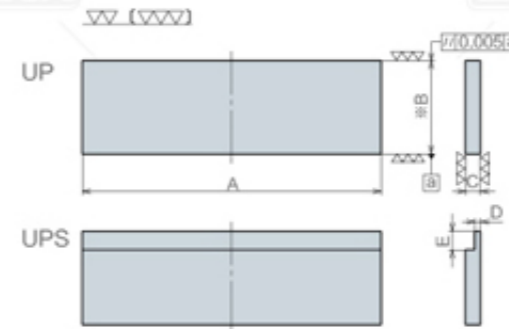

规格

通用尺寸			UP(无台阶)			UPS(带台阶)				
A	B	C	订单号	型号	重量kg	订单号	型号	D	E	重量kg
160	30	8	955665	UP1630	0.60	955688	UPS1630	3	10	0.47
160	35	8	955666	UP1635	0.70	955689	UPS1635	3	10	0.58
160	40	8	955667	UP1640	0.80	955690	UPS1640	3	10	0.67
160	45	8	955668	UP1645	0.90	955691	UPS1645	3	10	0.77
160	50	8	955669	UP1650	1.00	955692	UPS1650	3	10	0.87
160	51	8	955670	UP1651	1.03	955693	UPS1651	3	10	0.90
160	52	8	955671	UP1652	1.05	955694	UPS1652	3	10	0.92
160	53	8	955672	UP1653	1.07	955695	UPS1653	3	10	0.94
160	54	8	955673	UP1654	1.09	955696	UPS1654	3	10	0.96
160	55	8	955674	UP1655	1.10	955697	UPS1655	3	10	0.97
160	56	8	955675	UP1656	1.13	955698	UPS1656	3	10	1.02
160	57	8	955676	UP1657	1.15	955699	UPS1657	3	10	1.03
200	40	8	955677	UP2140	1.06	955700	UPS2140	3	10	0.90
200	45	8	955678	UP2145	1.19	955701	UPS2145	3	10	1.03
200	50	8	955679	UP2150	1.32	955702	UPS2150	3	10	1.15
200	55	8	955680	UP2155	1.46	955703	UPS2155	3	10	1.30
200	60	8	955681	UP2160	1.60	955704	UPS2160	3	10	1.44
200	61	8	955682	UP2161	1.62	955705	UPS2161	3	10	1.46
200	62	8	955683	UP2162	1.65	955706	UPS2162	3	10	1.49
200	63	8	955684	UP2163	1.67	955707	UPS2163	3	10	1.50
200	64	8	955685	UP2164	1.70	955708	UPS2164	3	10	1.54
200	65	8	955686	UP2165	1.73	955709	UPS2165	3	10	1.56
200	67	8	955687	UP2167	1.78	955710	UPS2167	3	10	1.62

使用例

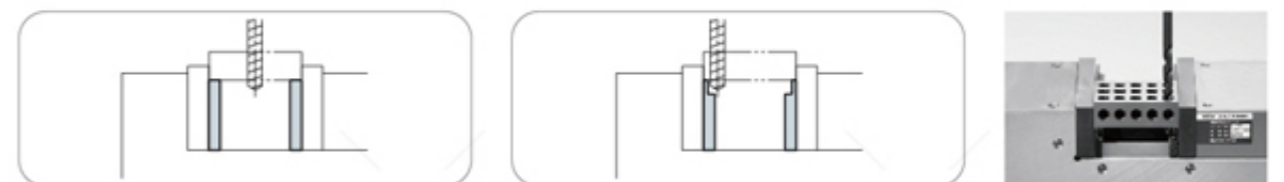



符合RoHS

HANDY DIGITAL PRESSURE GAUGES

便携式数字测力计

材质

显示部:硬质铝
传感器部:钢材

测定范围

0.5~50.0kN
(最小显示单位0.1kN)

附件

测力头(S50C、HRC50) — 1个
转接板(S45C) — 1个
锰干电池(DC9V) — 1个

- 只需1台测力计,可进行精密平口钳、液压夹具、卡盘的夹紧力检查。
- 传感器与数显部一体化,不会妨碍测定。
- 小型、轻量,携带方便。
- 采用干电池供电,可立刻使用。
- 可将传感器与显示部旋转90度,调整显示方向。
- 与波登管式测力计及测压元件式测力计相比,体积更小、重量更轻,并且无需导线。
- 1分钟自动关闭显示的省电型。

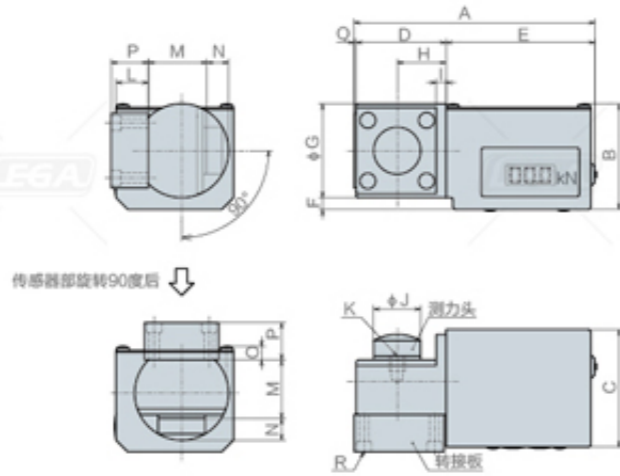

规格

订单号	型号	A	B	C	D	E	F	φG	H	I	φJ	K(粗牙)	L	M	N	O	P	Q	R(粗牙)	重量kg
978839	HDK-50C	123	53.9	60	46	76	6	48	25	5	24	M8×1.25深8	16.5	30	11	6.9	19	1	M4×0.7	800

使用例



符合RoHS

ACCESSORIES PARTS

精密平口钳附件

旋转台

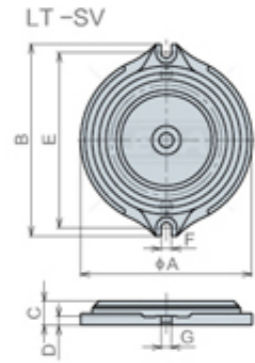
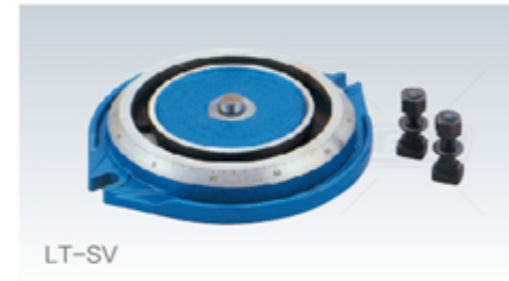

规格

适用机型	订单号	型号	A	B	C	D	E	F	G	重量kg
LT100M	932182	LT100M-SV	228	256	34	14	232	15	18	4.5
LT125M	932183	LT125M-SV	248	283	34	14	255	16	18	7
LT150M,LT150L,LTHPD150	932184	LT150M-SV	298	334	42	16	320	18	18	12
LT200M	932185	LT200M-SV	409	425	57	28	379	24	18	32

符合RoHS

ACCESSORIES PARTS

精密平口钳附件

安装螺栓

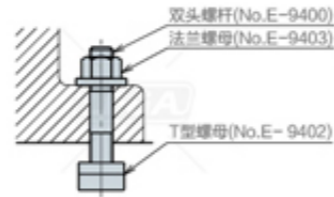

规格

适用槽宽	适用机型	订单号	型号	T型螺母	法兰螺母	双头螺栓	2组1套
12	LT100M	935843	BTS-12A	TNM1210	FNM0010	BM01075	
14	LT100M,LT125M,LT150M,LT150L,LTH3P-125,LTH3P-150S,LT-HPD150	935844	BTS-14A	TNM1412	FNM0012	BM01275	
16	LT100M,LT125M,LT150M,LT150L,LTH3P-125,LTH3P-150S,LT-HPD150	935845	BTS-16A	TNM1614	FNM0014	BM01475	
18	LT150M,LT200M,LT250M,LT150L,LTH3P-150S,LT-HPD150	935846	BTS-18A	TNM1816	FNM0016	BM16100	
18	LT100M,LT125M,LTH3P-125	935847	BTS-18B	TNM1814	FNM0014	BM01475	
20	LT200M,LT250M	935849	BTS-20A	TNM2018	FNM0018	BM18100	
20	LT150M,LT150L,LTH3P-150S	935850	BTS-20B	TNM2016	FNM0016	BM16100	
22	LT200M,LT250M	935852	BTS-22A	TNM2220	FNM0020	BM20100	

安装夹具

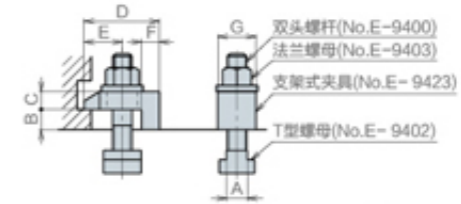

BCS-14B, C / BCS-16B, C, G, H / BCS-18B, C, F, G, H

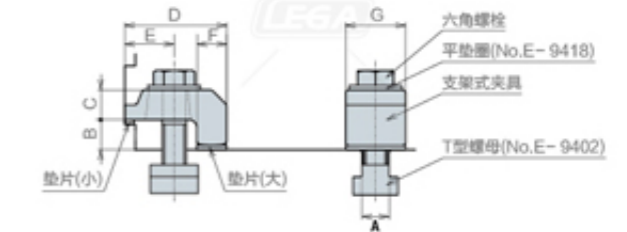

BCS-14Q1, BCS-18Q1, BCS-18Q2

规格

适用槽宽	适用机型	订单号	型号	A	B	C	D	E	F	G	支架式夹具	T型螺母	法兰螺母	双头螺栓	2组1套
14	LTCV100(S,H,SH),LTCV125(S,H,SH),LTCV160(S,H,SH,TH),LTCV200(S,H,SH,TH),LTPV100Q,LT150MC,LT150WL,LSAU100(F,M,FM)	935854	BCS-14B	13.5	17	15	63	27-37	15	32	LCMC121	TNM1412	FNM0012	BM01275	
14	LTFV75,LT100MC,LT100WL,LTAW100,LSAU-75(F,FM)	943967	BCS-14C	13.5	12	15	55	26-31	15	32	LCMC122	TNM1412	FNM0012	BM01275	
14	LTPV75,LT150MC,LT150WL,LSAU-75(F,FM)	997234	BCS-14Q1	13.5	12	20	63	23-38	15	32	专用夹具, 垫片	TNM1412K	六角螺栓M12X60, 平垫圈WF12		
16	LTCV100(S,H,SH),LTCV125(S,H,SH),LTCV160(S,H,SH,TH),LTCV200(S,H,SH,TH),LTPV100Q,LTPV125Q,TFH125Q,LT150MC,LT150WL,LSAU100(F,M,FM)	935856	BCS-16B	15.3	17	15	63	28-36	15	32	LCMC161	TNM1614	FNM0014	BM14100	
16	LTCV100(S,H,SH),LTCV125(S,H,SH),LTCV160(S,H,SH,TH),LTCV200(S,H,SH,TH),LTPV100Q,LTPV125Q,TFH125Q,LT150MC,LT150WL,LSAU100(F,M,FM)	935857	BCS-16C	15.3	17	15	95	41-71	15	32	LCMC162	TNM1614	FNM0014	BM14100	
16	LTPV150Q,TFH150Q,TFV175Q,TFH175Q	943968	BCS-16G	15.3	20	20	80	32-43	25	45	LCMC164	TNM1614	FNM0014	BM14100	
16	LTFV75,LT100MC,LT100WL,LTAW100	959333	BCS-16H	13.5	12	15	55	26-31	15	32	LCMC122	TNM1612	FNM0012	BM01275	
18	LTCV100(S,H,SH),LTCV125(S,H,SH),LTCV160(S,H,SH,TH),LTCV200(S,H,SH,TH),LTPV100Q,LTPV125Q,TFH125Q,LT150MC,LPFW100,LT150WL	935862	BCS-18B	17	17	15	63	28-36	15	32	LCMC161	TNM1816	FNM0016	BM16100	
18	LTCV100(S,H,SH),LTCV125(S,H,SH),LTCV160(S,H,SH,TH),LTCV200(S,H,SH,TH),LTPV100Q,LTPV125Q,TFH125Q,LT150MC,LT150WL,LSAU100(F,M,FM)	935863	BCS-18C	17	17	15	95	41-71	15	32	LCMC162	TNM1816	FNM0016	BM16100	
18	LTPV150Q,TFH150Q,TFV175Q,TFH175Q	943969	BCS-18G	17	20	20	80	32-43	25	45	LCMC164	TNM1816	FNM0016	BM16100	
18	LTFV75,LT100MC,LT100WL,LTAW100	959334	BCS-18H	17	12	15	55	26-31	15	32	LCMC122	TNM1812	FNM0012	BM01275	
18	LTCV100(S,H,SH),LTCV125(S,H,SH),LTCV160(S,H,SH,TH),LTCV200(S,H,SH,TH),LTPV100Q,LTPV125Q,TFH125Q,LT150MC,LSAU100(F,M,FM)	986725	BCS-18Q1	17	17	20	68	25-33	20	40	专用夹具, 垫片	TNM1816K	六角螺栓M16X70, 平垫圈WF16		
18	LTPV150Q,TFH150Q,TFV175Q,TFH175Q	986726	BCS-18Q2	17	20	20	68	25-33	20	40	专用夹具, 垫片	TNM1816K	六角螺栓M16X75, 平垫圈WF16		

符合RoHS

ACCESSORIES PARTS

精密平口钳附件

导轨块

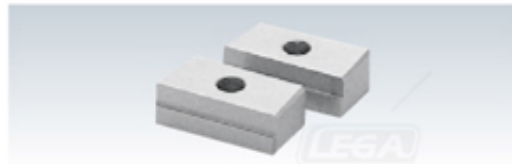

规格

※2个1组、带安装螺栓。材质:S45C

适用槽宽	适用机型	订单号	型号	A	B	C	D	E	F	G	H	适用螺栓
10	LTCV所有机型, LTFV<FH所有机型, LT-M-LT-MC-LT5AU-100(M,F,FM), LT150L, LT-JV, LTM-WL-LTAW, LTH3P-150S, LT-HPD150, MSV所有机型, SV-80, PV-2, PV-3, TP	955958	LTGB10-18	10	18	6.5	11	24	7	11	4.5	M6
12	LTCV所有机型, LTFV<FH所有机型, LT-M-LT-MC-LT150L, LT-JV, LTM-WL-LTAW, LTH3P-150S, LT-HPD150, MSV所有机型, SV-80, PV-2, PV-3, TP	932122	LTGB12-18	12	18	6.5	11	24	7	11	4.5	M6
	LTH3P125	966311	LTGB12-16	12	16	5.5	10	24	7	11	3.5	M6
	ETO-TH型所有机型, SV-56, LT5AU-75(F,FM)	966310	LTGB12-14	12	14	5.5	9	20	7	11	2.5	M6
14	LTCV所有机型, LTFV<FH所有机型, LT-M-LT-MC-LT5AU-100(M,F,FM), LT150L, LT-JV, LTM-WL-LTAW, LTH3P-150S, LT-HPD150, MSV所有机型, SV-80, PV-2, PV-3, TP	932123	LTGB14-18	14	18	6.5	11	24	7	11	4.5	M6
	LTH3P125	943868	LTGB14-16	14	16	5.5	10	24	7	11	3.5	M6
	LTFV75, E-173 ETO-TH型所有机型, SV-56, LT5AU-75(F,FM)	966312	LTGB14-14	14	14	-	9	20	7	11	2.5	M6
16	LTCV所有机型, LTFV<FH所有机型, LT-M-LT-MC-LT5AU-100(M,F,FM), LT150L, LT-JV, LTM-WL-LTAW, LTH3P-150S, LT-HPD150, MSV所有机型, SV-80, PV-2, PV-3, TP	932124	LTGB16-18	16	18	6.5	11	24	7	11	4.5	M6
	LTH3P125	943869	LTGB16-16	16	16	-	10	24	7	11	3.5	M6
	LTFV75, E-173 ETO-TH型所有机型, SV-56, LT5AU-75(F,FM)	966313	LTGB16-14	16	14	5.5	10	24	7	11	3.5	M6
18	LTCV所有机型, LTFV<FH所有机型, LT-M-LT-MC-LT5AU-100(M,F,FM), LT150L, LT-JV, LTM-WL-LTAW, LTH3P-150S, LT-HPD150, MSV所有机型, SV-80, PV-2, PV-3, TP	932125	LTGB18-18	18	18	-	11	24	7	11	4.5	M6
	LTH3P125	943870	LTGB18-16	18	16	5.5	11	24	7	11	4.5	M6
	LTFV75, E-173 ETO-TH型所有机型, SV-56, LT5AU-75(F,FM)	966314	LTGB18-14	18	14	5.5	11	24	7	11	4.5	M6
20	LTCV所有机型, LTFV<FH所有机型, LT-M-LT-MC-LT5AU-100(M,F,FM), LT150L, LT-JV, LTM-WL-LTAW, LTH3P-150S, LT-HPD150, MSV所有机型, SV-80, PV-2, PV-3, TP	932133	LTGB20-18	20	18	6.5	12	24	7	11	5.5	M6
	LTH3P125	943871	LTGB20-16	20	16	6.5	12	24	7	11	5.5	M6
	LTFV75, E-173 ETO-TH型所有机型, SV-56, LT5AU-75(F,FM)	966315	LTGB20-14	20	14	7.5	12	20	7	11	5.5	M6
22	LTCV所有机型, LTFV<FH所有机型, LT-M-LT-MC-LT5AU-100(M,F,FM), LT150L, LT-JV, LTM-WL-LTAW, LTH3P-150S, LT-HPD150, MSV所有机型, SV-80, PV-2, PV-3, TP	932134	LTGB22-18	22	18	8.5	14	24	7	11	7.5	M6
	LTH3P125	943872	LTGB22-16	22	16	6.5	12	34	7	11	5.5	M6
	LTFV75, E-173 ETO-TH型所有机型, SV-56, LT5AU-75(F,FM)	966316	LTGB22-14	22	14	9.5	14	20	7	11	7.5	M6
24	LTCV所有机型, LTFV<FH所有机型, LT-M-LT-MC-LT5AU-100(M,F,FM), LT150L, LT-JV, LTM-WL-LTAW, LTH3P-150S, LT-HPD150, MSV所有机型, SV-80, PV-2, PV-3, TP	951959	LTGB24-18	24	18	10.5	16	24	7	11	9.5	M6
28	LTCV所有机型, LTFV<FH所有机型, LT-M-LT-MC-LT150L, LT-JV, LTM-WL-LTAW, LTH3P-150S, LT-HPD150, MSV所有机型, SV-80, PV-2, PV-3, TP	951960	LTGB28-18	28	18	10.5	16	24	7	11	9.5	M6

工件限位器

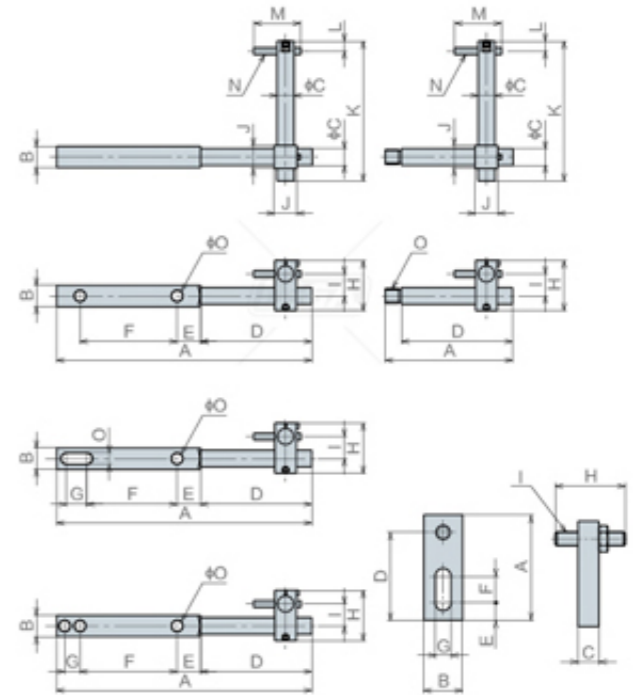

规格

适用机型	订单号	型号	A	B	C	D	E	F	G	H	I	J	K	L	M	N	O	适用安装螺栓
LT100M, LT100MC, LT100SP	932172	LT100M-WST	168	19	16	75	23	60	-	51	18	22	108	12	40	M6x1.0	9	M8
LT125M, LT150M, LT150MC, LTHPD150, LT125SP, LTHPD150	932174	LT150M-WST	242	22	19	108	24	77	23	57	22	25	153	13	50	M8x1.25	13	M12
LT200M, LT250M	932175	LT200M-WST	388	32	25	173	60	119	21	80	28	32	245	20	80	M10x1.5	17	M16
LTCV100(S,H,SH), LTCV125(S,H,SH), LTCV160(S,H,SH,TH), LTCV200(S,H,SH,TH), LTH3P-125, LTH3P-150S, L7630JV	910272	LTH3P-150WST	115	-	19	100	-	-	-	57	22	25	153	13	50	M8x1.25	M12 x 1.75	-
LTFV75, SV56, SV80, MSV300(S), MSV400(S,K), MSV410(S), MSV500(S,K), MSV510(S), ETO80TH, ETO100TH, ETO125TH	962535	LTF75-WST	45	16	9	37	9	10	7	40	M6 x 1.0	-	-	-	-	-	-	M6
LTFV100Q, LTFV-LTFH125Q, LTFV-LTFH150Q, LTFV-LTFH175Q, LT100MC, LT150MC, LTM100WL, LTM150WL, LTAW100	962536	LTF100-WST	60	22	12	50	10	15	9	50	M8 x 1.25	-	-	-	-	-	-	M8

使用例

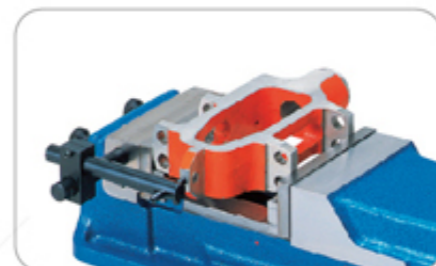

符合RoHS

ACCESSORIES PARTS

精密平口钳附件

钳口

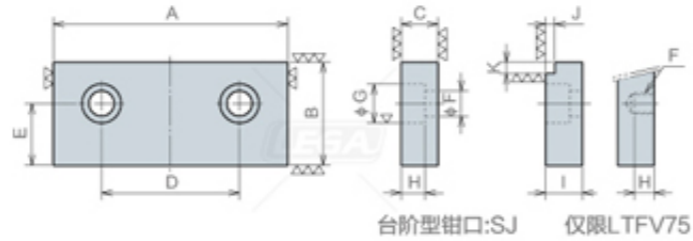
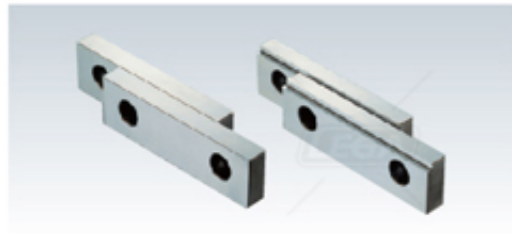

台阶型钳口: SJ 仅限LTFV75

尺寸表

适用机型	A	B	C	D	E	F	G	H	J	K	适用螺栓	I
LTCV100(S,H,SH),LT5AU-100F(M)	102	45	12	60	27	11	18	7	4	5	M10	16
LTCV125(S,H,SH)	125	50	12	75	30	11	18	7	4	5	M10	16
LTCV160(S,H,SH,TH)	160	60	12	90	35	11	18	7	5	6	M10	19
LTCV200(S,H,SH,TH)	200	70	12	130	40	11	18	7	5	6	M10	19
LTFV75	76	32	14	46	18	M8	-	-	4	5	M8	14
LTFV100Q	102	45	16	60	27	11	18	10.5	4	5	M10	16
LTFV·LTFH125Q	125	50	16	75	30	11	18	10.5	4	5	M10	16
LTFV·LTFH150Q	150	60	19	90	35	13	19	12.5	5	6	M12	19
LTFV·LTFH175Q	175	70	19	90	45	13	19	12.5	5	6	M12	19
LT630JV	160	75	19	85	35	13	19	12.5	5	6	M12	19
LT100M,LT100MC,LT100SP,LTM100WL	101	32	14	60	18	9	14	8.5	3.5	4	M8	14
LT125M,LT125SP	126	38	19	77	21	13	19	12.5	3.5	4	M12	19
LT150M,LT150MC,LT-HPD150	151	44.2	19	100	24	13	19	12.5	4.5	5	M12	19
LT200M	202	57	29	119	31	17	25	17	5.5	6	M16	29
LT250M	253	75.5	34	140	41	17	25	17	5.5	6	M16	34
LT150L,LTM150WL	151	44.2	14	100	24	11	18	10.5	4.5	5	M10	14
LTH3P-150S	156	57	14	90	25	11	18	10.5	6	7	M10	14
LT5AU-75F(M)	75	32	14	32	18	9	14	8.5	-	-	M8	-

规格

2片1组

适用机型	标准钳口		台阶型钳口	
	订单号	型号	订单号	型号
LTCV100(S,H,SH),LT5AU-100F(M)	978206	LTCV100-JA	930336	LTF-100SJ
LTCV125(S,H,SH)	978207	LTCV125-JA	930337	LTF-125SJ
LTCV160(S,H,SH,TH)	978208	LTCV160-JA	978209	LTCV160-SJ
LTCV200(S,H,SH,TH)	984582	LTCV200-JA	984583	LTCV200-SJ
LTFV75	962537	LTF-75JA	962538	LTF-75SJ
LTFV100Q	930332	LTF-100JA	930336	LTF-100SJ
LTFV·LTFH125Q	930333	LTF-125JA	930337	LTF-125SJ
LTFV·LTFH150Q	930334	LTF-150JA	930338	LTF-150SJ
LTFV·LTFH175Q	930335	LTF-175JA	930339	LTF-175SJ
LT630JV	919772	LT630JV-JA	919911	LT630JV-SJ
LT100M,LT100MC,LT100SP,LTM100WL	932161	LT100M-JA	932162	LT100M-SJ
LT125M,LT125SP	932163	LT125M-JA	932164	LT125M-SJ
LT150M,LT150MC,LT-HPD150	932165	LT150M-JA	932166	LT150M-SJ
LT200M	932167	LT200M-JA	932168	LT200M-SJ
LT250M	932169	LT250M-JA	932170	LT250M-SJ
LT150L,LTM150WL	955470	LT150L-JA	955471	LT150L-SJ
LTH3P-150S	969385	LTH3P150S-JA	969386	LTH3P150S-SJ
LT5AU-75F(M)	993022	LT5AU-75JA-32	-	-

使用例

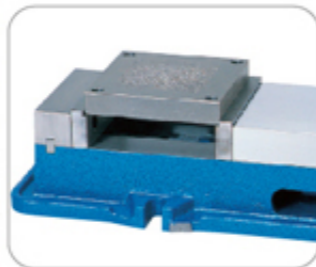

手柄



LT-13HN176 LT-14HN176
LT-16HN200 LT-19HN255
LT-22HN300 LT-22HN500

LT-13HN250
LT-13HN370
LT-10HN250

LT-14HN210C

机械式

LT-13HN180

LT-14HN195C

LT-14HN185C
LT-14HN195C

液压式

固定式

规格

适用机型	A	B	C	六角头对边宽	订单号	型号
LT-HPD150	111.5	168	-	13	943944	LT-13HN176
LTM100WL,LTAW100	103	168	-	14	943945	LT-14HN176
LT100M,LT100SP	44	168	-	14		
LTFV75	64	168	-	14		
LT100MC	70.5	168	-	14	943946	LT-16HN200
LTCV100(S),LTCV125(S)	87	189	49	16		
LT125M	58	189	-	16		
LT125SP	58	189	-	16	943947	LT-19HN255
LTCV160(S),LTCV200(S)	98	246	60	19		
LT150M	67	246	-	19		
LT150L	81	246	-	19	943948	LT-22HN300
LT150MC	97	246	-	19		
LTM150WL	151.5	246	-	19		
LT200M	76.5	277	-	22	943949	LT-22HN500
LT250M	91.5	504	-	22	943950	LT-14HN195C
LT630JV	146·296	197.5	-	14	969397	LT-14HN185C
LTH3P-150S	129~429	197.5	-	14	943951	LT-14HN210C
LTCV100(S),LTCV125(S),LTCV160(S),LTCV200(S)	190	192.5	-	14		
LTCV-160TH,LTCV-200TH	208.5	192.5	-	14		
LTFH150Q,LTFH175Q,LTFV150Q,LTFV175Q	231.5	192	-	13	962539	LT-13HN180
LTFH125Q,LTFV125Q	209.5	192	-	13		
LTFV100Q	189.5	192	-	13		
LT5AU100(F,M,FM)	78	245.5	-	13	988805	LT-13HN250
LT5AU100(F,M,FM)	77	368.5	-	13	988806	LT-13HN370
LT5AU-75(F,FM)	78	245.5	-	10	996856	LT-10HN250

精密平口钳附件

精密平口钳附件

CAD文件下载, 请登录: www.legadlamp.com

CAD文件下载, 请登录: www.legadlamp.com